

PE-L20DA 20W

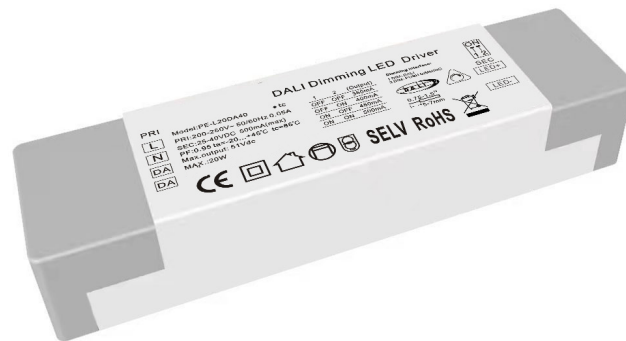

5 years     **RoHS SELV CE Class 2**

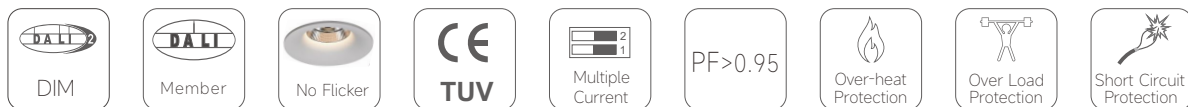

Features:

1. Dali standard interface and standard DT6 protocol conform to Dali 144 standards
2. Dali2 certification, Dali member
3. Digital control output is adopted, and there is no stroboscopic
4. AC input 200-250v range
5. Natural air cooling, moisture-proof, heat conduction, silica gel heat dissipation process
6. Deep dimming design
7. Multiple protection functions
8. Ultra small volume design
9. Crimping design, convenient and fast
10. 4 gear current selection

Application:

1. Led light source
2. Villa intelligent lighting
3. Wireless intelligent lighting system can be accessed
4. Museum lighting
5. High end commercial lighting

General description:

1. The standard Dali signal is used to control the brightness and slow up time. One power supply only occupies one address. The raw materials used are first-line brands, and the imported chips are super high Deep dimming design, matching a variety of Dali intelligent dimming systems and KNX Protocol Intelligent Systems on the market. Accurately control the brightness of the light, with silicone heat conduction inside. The technology makes the heat dissipation balance of electronic components more stable.

Specification:

| | Model | PE-L20DA40 | PE-L20DA4040 |
|----------------------|--------------------------|---|-------------------|
| OUTPUT | Output Voltage | 25-40Vdc | 25-40Vdc |
| | Max Output Voltage | 40Vdc | 40Vdc |
| | Non-load Output Voltage | 51Vdc | 51Vdc |
| | Output Current | 350/400/450/500mA | 250/300/350/400mA |
| | Output Power | 8.75W~20W | 6.5W~16W |
| | Strobe Level | No Flicker | |
| | Dimming Range | 0~100%, LEDstart at 0.03%possible. | |
| | PWM Dimming Frequency | >3600Hz | |
| | Current Accuracy | ±5% | |
| | Power down mode | memory function when power down | |
| INPUT | Dimming Interface | DALI (IEC62386)Signal control current < 2mA | |
| | Input Voltage Range | 200-250Vac | |
| | Frequency | 50/60Hz | |
| | Input Current | <0.1A ac230v | |
| | Power Factor | PF>0.96/230V ac(at full load) | |
| | THD | 230Vac@THD <6% (at full load) | |
| | Efficiency(typ.) | 86% | |
| | Inrush Current(typ.) | cold start25A@230Vac | |
| | Anti Surge | L-N: 1.8kV | |
| | Leakage Current | <0.25mA/230Vac | |
| ENVIRONMENT | Working Temperature | ta: 45°C tc: 80 °C | |
| | Working Humidity | 20 ~ 95%RH, non-condensing | |
| | Storage Temp., Humidity | -40 ~ 80°C, 10~95%RH | |
| | Temp.Coefficient | ±0.03%/°C(0-50)°C | |
| | Vibration | 10~500Hz, 2G 12min./1cycle, period for 72min. each along X, Y, Z axes. | |
| PROTECTION | Over-heat Protection | Intelligently adjusting or turning off the output current if the PCB temperature ≥110°C, , auto recovers. | |
| | Over Load Protection | Shut down the output when rated power≥102%, auto recovers. | |
| | Short Circuit Protection | Shut down automatically if short circuit occurs, auto recovers. | |
| | Non-load Protection | output Constant Voltage. | |
| SAFETY & EMC | Withstand Voltage | I/P-O/P: 3750Vac | |
| | Isolation Resistance | I/P-O/P: 100MΩ/500VDC/25°C/70%RH | |
| | Safety Standards | IEC/EN61347-1, IEC/EN61347-2-13 | |
| | EMC Emission | EN55015, EN61000-3-2 Class C, IEC61000-3-3 | |
| | EMC Immunity | EN61000-4-2,3,4,5,6,8,11, EN61547 | |
| Strobe Test Standard | IEEE 1789 | | |
| OTHERS | Dimension | 130×37×22.6mm(L×W×H) | |
| | Packing | PE bag | |
| | Weight(G.W.) | 110g±10g | |

Dimensions :

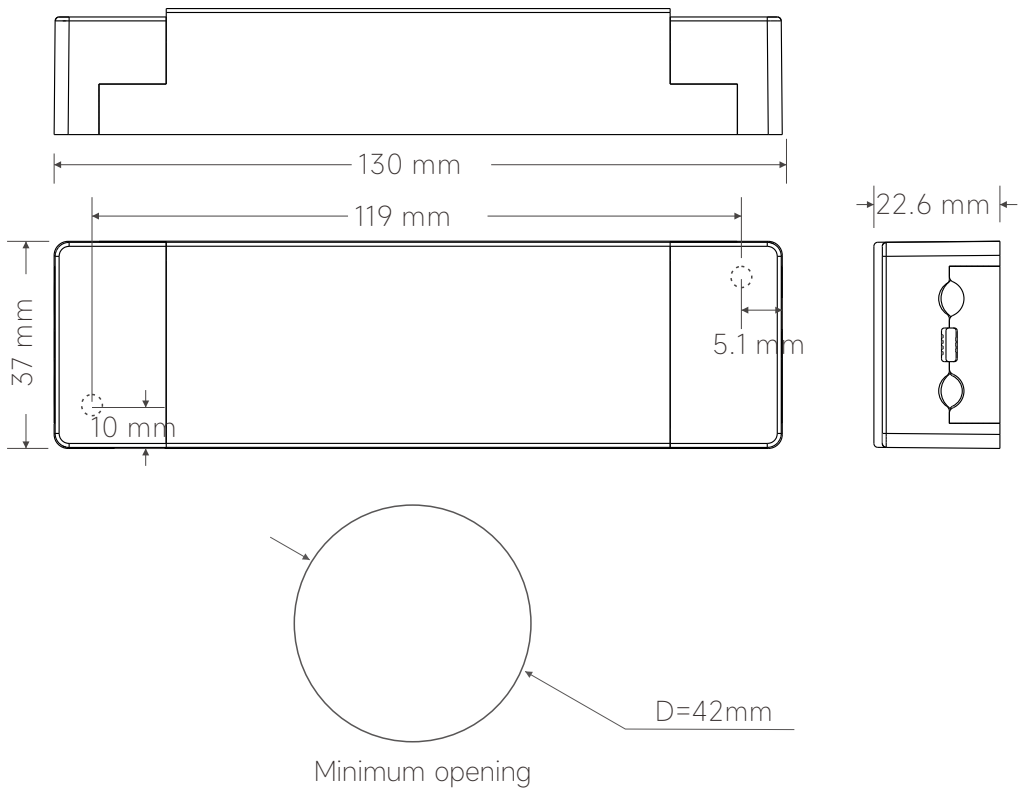

Product Label:

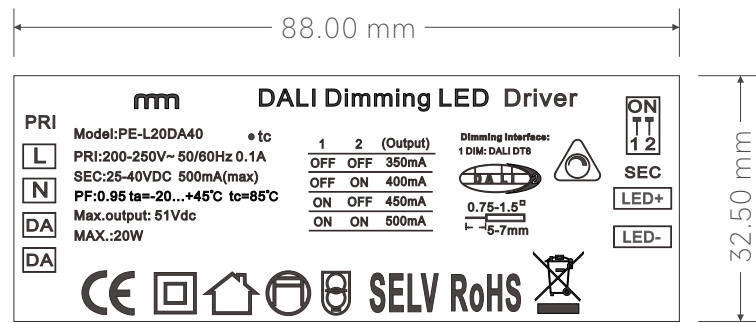

LED Current Selection:

DIP switch for 4 optional currents' quick selection(see the table below).

| | | | | | |
|--------------|----------------|--------|--------|--------|--------|
| PE-L20DA4050 | DIP Switch | | | | |
| | Output Current | 350mA | 400mA | 450mA | 500mA |
| | Output Voltage | 25-40V | 25-40V | 25-40V | 25-40V |
| PE-L20DA4035 | DIP Switch | | | | |
| | Output Current | 250mA | 300mA | 350mA | 400mA |
| | Output Voltage | 25-40V | 25-40V | 25-40V | 25-40V |

Dimensions :



Wiring:

1. Input terminal wiring: suitable for wire gauge 22awg-14awg (0.5mm² – 1.5mm²), stripping requires 9-10mm tin
2. Output terminal wiring: suitable for wire gauge 22awg-12awg (0.5mm² – 1.5mm²), stripping requires 6-7mm tin

Working Curve:

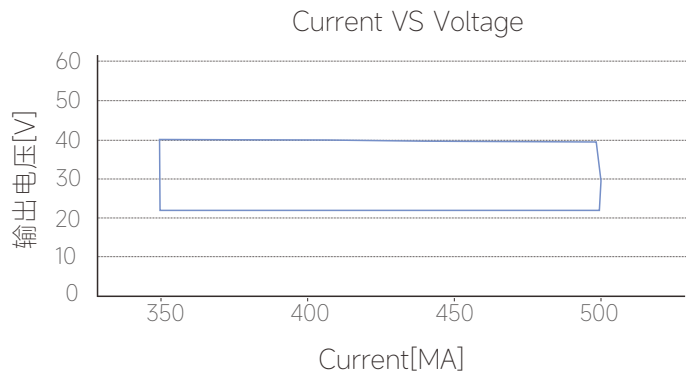
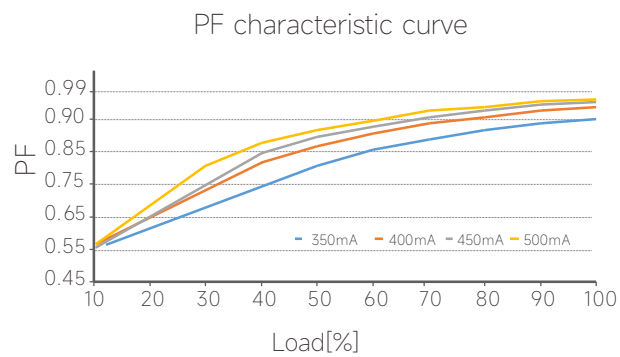
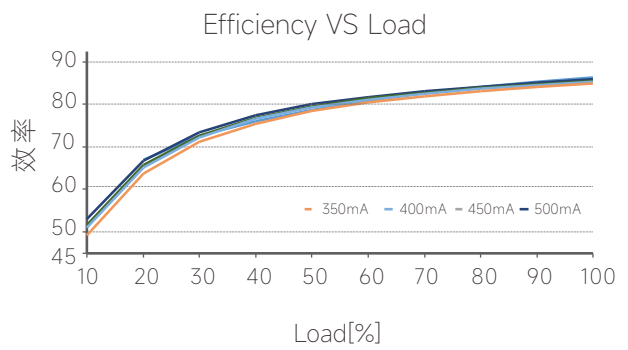
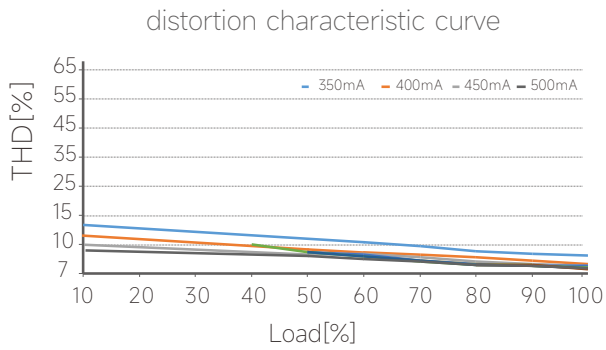

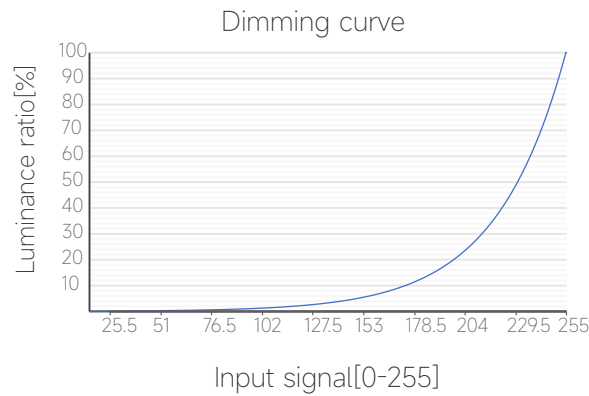

The use of guidance:

Unless otherwise specified, all specifications and parameters are measured at 230VAC input, rated load and 25 °C Ambient Temperature

This product has a press line cap at the input, with self-locking clamping, it can be opened up with a screwdriver, then you will see the input terminal connected with the AC line L and the null lime N, The output terminal connect a according to the product label, notice the positive and negative pole.

**1:please pay attention to the distinction between input and out put , connect correctly, then power on

**2:please connect first the load of the DC output, open the driver after checking; in the constant current mode, if power on at open circuit, please turn off the driver and can't connect the LED until the electric energy stored by the output release, or it may damage the LED ;

**3.this type of driver is only limited to the use of the LED lamps ,the input voltage range is AC200-250V,the heat insulation cotton and other items that obstruct the heat dissipation of the product, which conforms to the product under the specified output voltage, current range, the use environment temperature is -20-45 degrees, and the surface can not cover the conditions of the environment, this product enjoys 5 years of free warranty.

1.the LED lamp doesn't bright after the dimming driver is connected at the first time, please turn off the AC input and check as follow:

- 1)whether or not DC output bad contact;
- 2)whether DC output polarity is reversed, or the LED board is welded anti;
- 3)whether AC input is bad contact, test after eliminating these failures;

2.the device has good connection, LED lights, but the LED flicker, please turn off the AC input and check as follow:

- 1).whether or not the parameters and actual parameters match.
- 2).please timely communicate with us if you have any questions in the using, we will try our best to solve the problems with you.

The abnormal conditions and the corresponding treatment methods:

Digital Addressable lighting Interface (DALI)

DALI slave unit will send data only master unit requests, that is, adopt command answering mode

There are 64 slave units at most in the same DALI network, each unit has a separate address(short address), A salve unit can also be assigned to a certain group, and a slave unit can belong to different group, salve unit can exist up to 16 groups at the same time, each unit can set 16 scenarios.

The main features of the DALI protocol

- 1)Asynchronous serial communication.
- 2)1200 baud rate, using the Manchester encoding format.
- 3)Two lies differential signal.
- 4)The high level when differential voltage is larger than 9.5V.
- 5)The low level when differential voltage is less than 6.5V.
- 6)The master unit controls communication process.
- 7)One DALI bus can connect with 64 slave units.
- 8)Each slave unit can be individually addressed.

DALI Electrical Specification

Under the idle state, from machine unit method to control the bus:

- 1)High Output power at ordinary time, not to interference in the hold signal.
- 2)Output low electricity at ordinary time, directly to the DALI bus short circuit to each other.
- 3)DALI bus maximum current of 250mA
- 4)Not a two-way communication at the same time.
- 5)Transmission cable up to 300 meters, or pressure drop is no more than 2v

Statement:

The pictures and specifications are for reference, subject to the real object.
If there is any change in the specifications, it will be notified separately.